

NA - RX100V
Instruction manual



FORWARD

Thank you for your purchase of a NAUTICAM housing.

At NAUTICAM, we pride ourselves in the ability to recognise the requirements of professional as well as amateur underwater photographers and fulfill them through the innovative designs of our products. We strive to achieve a high level of user-friendliness by allowing stress-free installation and easy operation of all important functions of the camera.

Each housing is individually inspected and water pressure tested to ensure optimum quality.

Please read this manual carefully before using the housing, this will maximise its performance as well as its lifetime.

TABLE OF CONTENTS

Warranty	4
Precautions	5
Package Contents	7
Specifications	8
Identification of Parts	9
Opening and Closing the Housing	13
Preparation of the Housing	15
Installing the Camera	19
Installing Handle Brackets and Shutter Release Extension	20
Installing HDMI Bulkhead (optional)	23
Care and Maintenance	26
Optional Accessories	27

WARRANTY

All NAUTICAM Products are warranted against any material and manufacturing defects for two years from the date of purchase for consumer use. Please fill in the warranty cards shipped with our housings and viewfinders at the time of sale and return them to your point of purchase within a month. If we do not receive the completed warranty card for a particular product, the warranty period would be assumed to begin from the day that the product is shipped from our facility. This warranty only applies to products purchased from authorised NAUTICAM dealers and does not extend beyond the original retail purchaser.

To return your product for service, please contact your regional authorized service centre(s). Please note that this warranty only applies when the product is purchased in the territory where the service centre is located.

NAUTICAM accepts no liability for any damage to and defects in the housing caused by improper use and/or poor maintenance; it is the responsibility of the owner to carefully follow the instructions in our manuals.

NAUTICAM does not hold responsibility for damage, of any nature, to any equipment used with and/or placed within our products.

NAUTICAM accepts no liability for any loss of captured images or the inability to capture images even if it is due to the malfunctioning of our products.

Unauthorised modifications and/or repairs of our products will automatically invalidate the warranty.

PRECAUTIONS

- A water-tight test without the camera inside the housing is highly recommended when using the system for the first time and after the changing of port and O-ring(s).
- Do not use lubricants from other brands with the silicone rubber O-ring on this housing, only use the lubricant provided by NAUTICAM.
- Discontinue use immediately should you notice any leakage.
- Store the housing in a robust, shock-proof container during transportation; avoid transporting with any equipment, such as a camera, inside the housing.
- When travelling by air, do not close the housing as this may lead to a pressure difference between the atmosphere and inside the housing.
- Care must be taken when opening the housing, as pressure may build up inside the housing which increases the opening force.

- Do not open the product in a wet or sandy environment. Protect the interior from moisture and debris in order to prevent malfunction or leakage.
- Do not store the product in an environment of high humidity.
- Do not leave the housing and the monitor in direct sunlight for prolonged periods.
- Keep out of reach of children, failure to do so could result in injury.
- Defective products should be shipped to our distributors for service, unauthorized disassembling and/or modifications could result in malfunction or leakage.

PACKAGE CONTENTS

- NA-RX100V housing
- Set of handle brackets with shutter release extension
- Spare silicone rubber O-ring for housing
- O-ring remover
- CR2032 battery
- Lubricant
- Set of Allen keys
- Instruction manual

SPECIFICATIONS

Construction	Housing body:	Aluminium alloy
	Surface treatment:	Hard anodised
	Display window:	Abrasion resistant polycarbonate
Dimensions	Width:	150mm
	Height:	101mm
	Depth:	109mm
Weight	Approx. 0.85kg	
Buoyancy	Slightly negative	
Depth rating	100 metres	
Compatible camera	Sony Cyber-shot DSC-RX100 V Digital Camera	

IDENTIFICATION OF PARTS

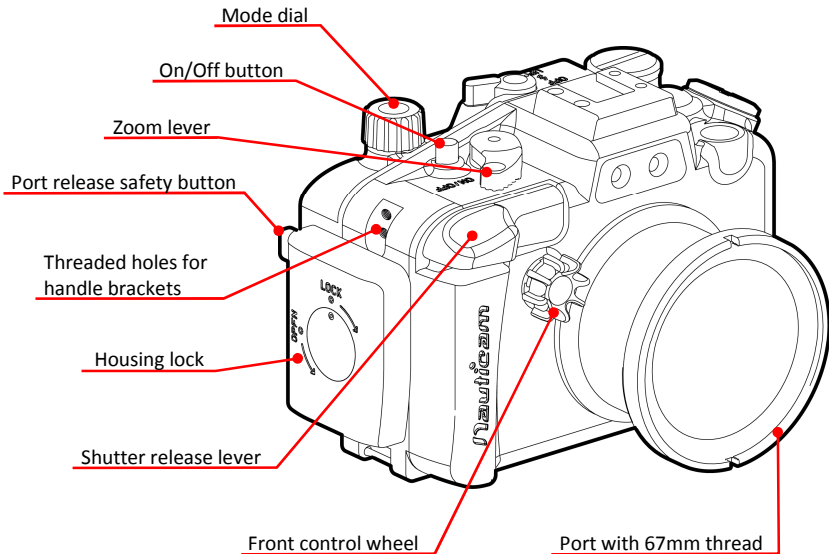

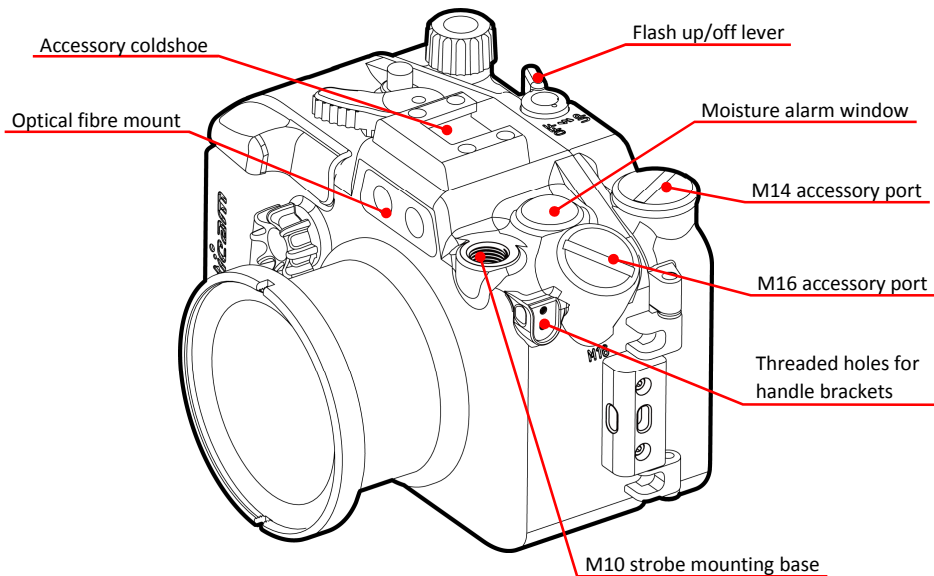

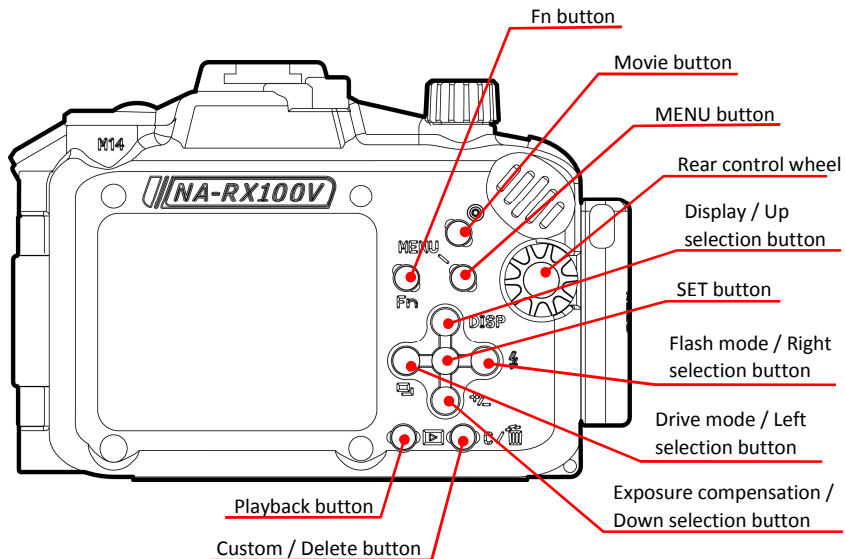

Mounting holes for LCD
magnifier attachment rails

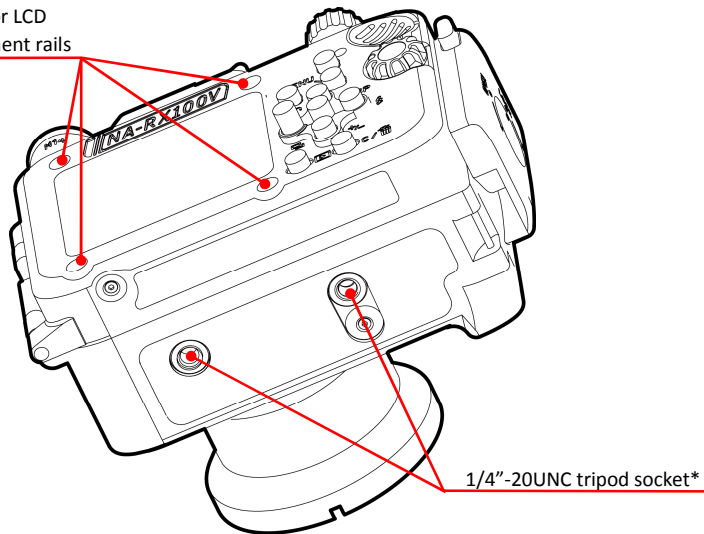

*The maximum length of screws that can be used with the tripod socket is 4mm

OPENING AND CLOSING THE HOUSING

To open the housing:

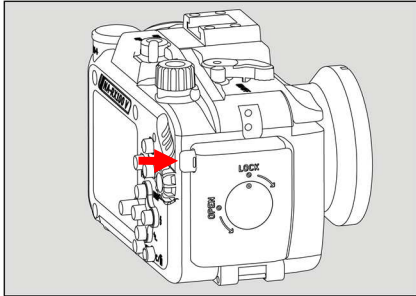

1. Press the housing lock safety button.

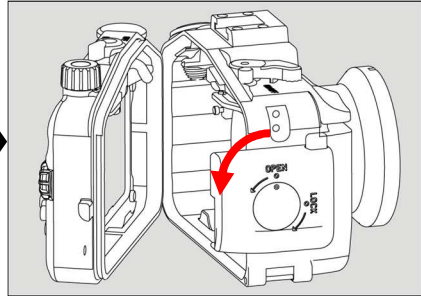

2. Turn the housing lock anti-clockwise for 270°, until the lock reaches the "Open" position as shown.

To close the housing:

When closing, make sure there is nothing caught between the closing surfaces of the two halves of the housing.

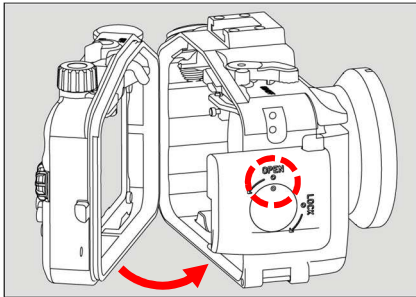

3. Close the housing while the housing lock is in the “Open” position.

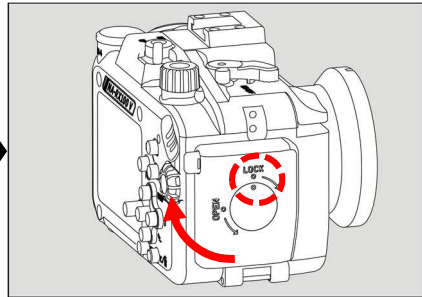

4. Turn the housing lock clockwise for 270°, until the lock reaches the “lock” position as shown. Confirm that the white indicator line on the safety button is visible.

PREPARATION OF THE HOUSING

1. After verifying that the main O-ring is in good condition, lightly coat it with the lubricant provided.
2. Make sure the O-ring groove located in the front part of the housing is free from any foreign material; the groove can be cleaned with the aid of a microfiber cloth.
3. Place the main O-ring into the groove, first at the corners, then the whole perimeter.
4. *Optional:* If necessary, spacers (#25011) can be used to increase space between the grip handles and the housing; A pair of small handles (#28123) is also available to decrease space between the grip handles and the housing.

5. Setting up the moisture alarm:

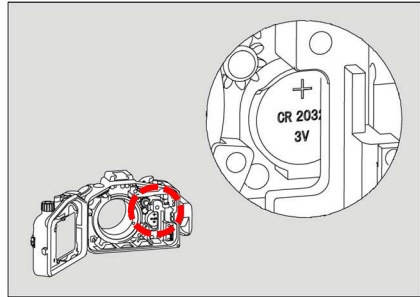

1. Install the CR2032 battery provided into the battery compartment on the circuit board inside the front part of the housing.

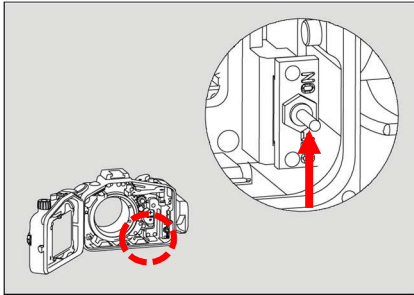

2. Switch the alarm on. The LED light will flash blue once and turn blue for five seconds indicating the battery is normal. Then it goes into flashing blue light standby mode.

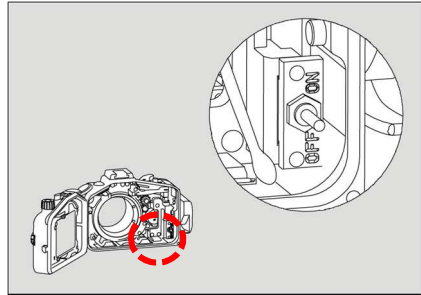

3. Test the alarm by connecting the two wires near the bottom of the housing with a damp cotton bud; the alarm should start giving out a repeating “beep” sound along with a flashing red light. The “beep” sound and the light should keep on going for 5 seconds after the removal of the damp cotton bud.

Optional Vacuum Valve:

Vacuum valve can be attached to the housing via one of the accessory port for conducting a vacuum seal test. Please refer to the manual of the vacuum valve for details of the operation.

LED status identification:

On start up:

<i>LED indicator</i>	<i>Status</i>
Flash "Blue" light once	Indicates a 2nd generation PCB
Steady "Blue" light	Battery is normal, goes into flashing "Blue" light standby mode after 5 seconds.
"Blue" and "Red" lights alternating	Battery low. Replace battery as soon as possible. Goes into standby mode after 5 seconds.
Steady "Red" light	Battery empty, replace battery.

After start up:

<i>LED indicator</i>	<i>Status</i>
Flashing "Blue" light	Standby mode. The moisture alarm is active, and the system is ready for vacuum indication whenever a vacuum is detected.
Flashing "Red" light with beeping sound	Moisture is detected.
Flashing "Yellow" light	Some vacuum is detected, target vacuum level is not reached.
Steady "Green" light	Target vacuum level is reached.
Rapidly flash "Yellow" light	Vacuum is dropping. (Will occur only after target vacuum level is reached)
Rapidly flashing "Red" light	Vacuum is totally lost. Circuit stalled until switched off. (Will occur only after target vacuum level is reached)

INSTALLING THE CAMERA

To install the camera into to the housing:

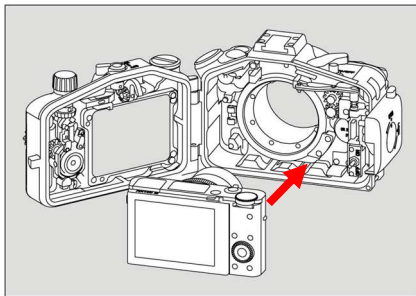

1. Place the camera inside the housing as shown.

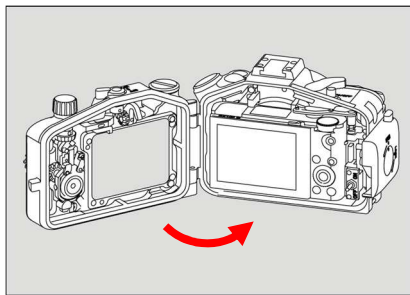

2. Close the housing and confirm that all the controls of the housing are correctly engaged.

INSTALLING HANDLE BRACKETS AND SHUTTER RELEASE EXTENSION

A pair of handle brackets is supplied with the housing for use with optional Easitray (#71206) or Flexitray (#71207) with right handle (#71208), providing additional stability. Strobe mounting balls (#71311) are required.

To install the handle brackets:

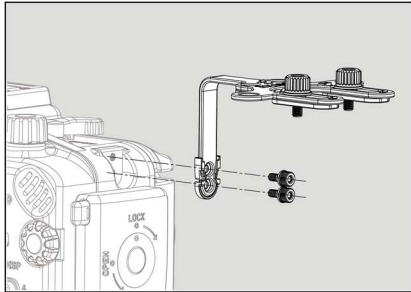

1. Locate the mounting holes on the side of the housing and install the handle bracket to the housing as shown. Remove the retaining nuts before mounting the bracket.

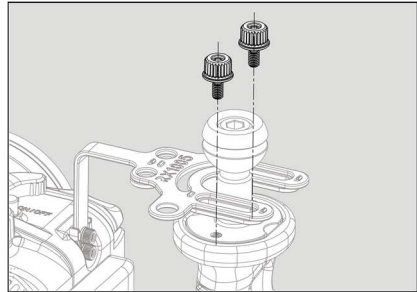

2. Attach the tray to the housing and align the bracket to the threaded holes of 71311. Adjust the position of the handle if needed.

The Shutter release extension provides easy shutter release access from the handle grip for users with big hand, or thick drysuit gloves who prefer shooting from a handle.

To install the shutter release extension:

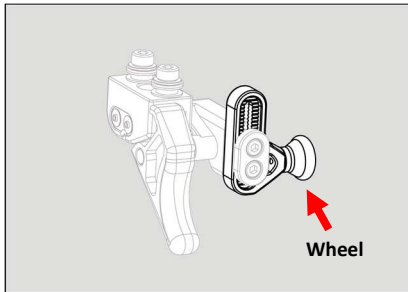

1. Confirm that the wheel is located at the bottom as shown above.

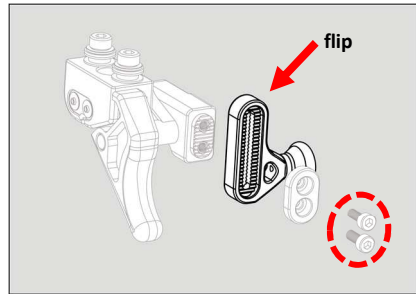

The position of the wheel can be switched by removing the two screws as indicated and flip the wheel assembly to the preferred position.

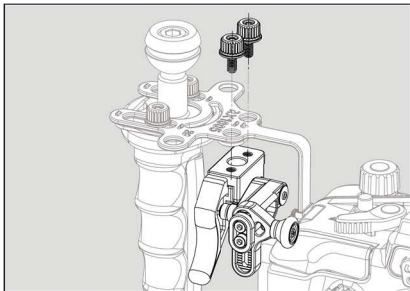

2. Mount the shutter release extension onto the right handle bracket as shown.

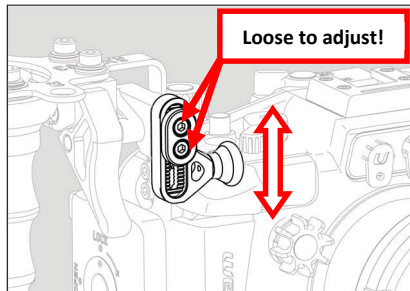

3. Loosen the two screws as shown until the wheel assembly can freely move vertically. Then adjust the position of the wheel so that it touches on the housing shutter release lever and then tighten it..

INSTALLING HDMI BULKHEAD (OPTIONAL)

This housing is compatible with HDMI output to external monitor with optional monitor housing. A specific HDMI bulkhead (#25032) and socket extension (#25028) are required

To install the HDMI bulkhead and socket extension on M16 accessory port:

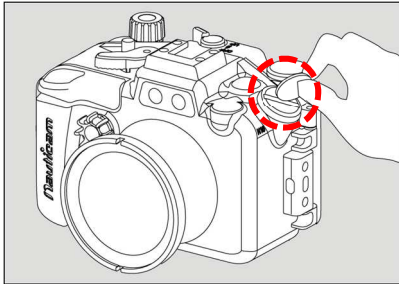

1. Unscrew the M16 plug from the threaded hole with a coin.

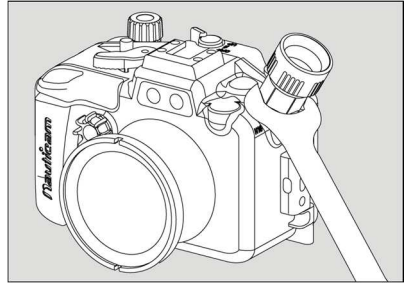

2. Tighten the socket extension to the camera housing with a spanner.

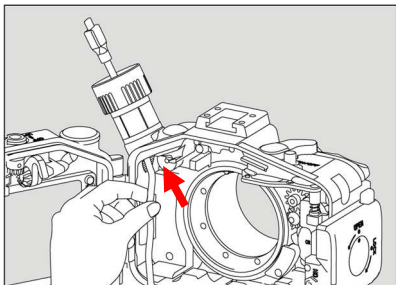

3. Open the housing and insert the HDMI cable through the threaded hole from inside of the housing.

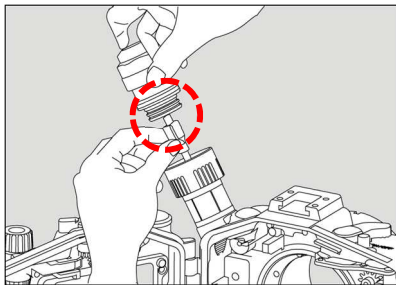

4. Connect the HDMI cable to the HDMI bulkhead.

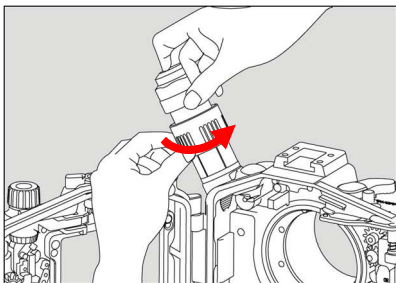

5. Tighten the HDMI bulkhead by turning the threaded ring on the socket extension.

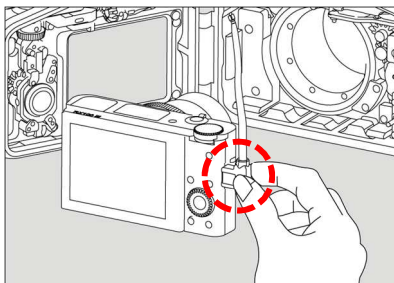

6. Connect the HDMI cable to the camera's HDMI connector before placing the camera inside the housing.

Please refer to the monitor housing manual for connection between camera housing and monitor housing.

CARE AND MAINTENANCE

- Soak the housing system in fresh water after each salt water use, during which all control buttons/knobs should be operated a few times to avoid the accumulation of salt residue; wipe the housing with a towel before opening.
- Carefully press the housing lock safety button for a few times to avoid the accumulation of salt residue.
- After each day of diving, it is advisable to have the main O-ring in the front part of the housing removed from its groove with the O-ring remover and inspected for damage. Also check that the O-ring retains its original circular shape; never stretch the O-ring excessively or remove it with a sharp object. The O-ring groove should be cleaned to ensure it is free from any salt deposit or foreign material; lightly coat the O-ring with the provided lubricant before reinstalling it in the groove. A damaged O-ring should be discarded immediately and replaced only with one that is provided by NAUTICAM.
- Replace the main O-ring annually. It is recommended that you ship the housing to our distributor for a complete overhaul every year or after every 200 dives.

OPTIONAL ACCESSORIES

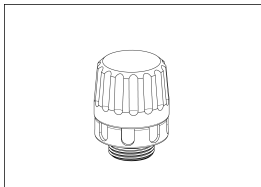

P.N. 25624
M14 Vacuum Valve II
(Pushbutton Release)

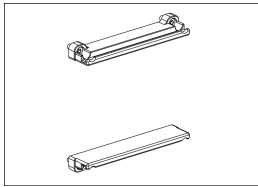

P.N. 25131
LCD Magnifier attachment rails
for NA-RX100III/RX100IV/RX100V

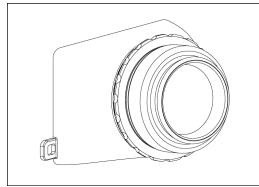

P.N. 25106
LCD Magnifier with Dioptic
Adjustment



NAUTICAM International Limited

**Rm2203, CCT Telecom Building,
11 Wo Shing Street, Fotan,
HONG KONG**

**Web: www.nauticam.com
E-mail: enquiry@nauticam.com
Tel: +852 2690 2711
Fax: +852 2690 9778**

